

U.S. Suggested Retail Price List

January 2015

Phone: 1-800-336-7684

Fax: 704-882-0751

www.snugseat.com

PO Box 1739 Matthews, NC 28106

Account No. \_\_\_\_\_ Drop Ship: \_\_\_\_\_  
 Date: \_\_\_\_\_ Name \_\_\_\_\_  
 P.O. Number: \_\_\_\_\_ Address \_\_\_\_\_  
 Buyer: \_\_\_\_\_ City \_\_\_\_\_  
 Marked For: \_\_\_\_\_ State \_\_\_\_\_ Zip \_\_\_\_\_  
 E Mail: \_\_\_\_\_ Tel. \_\_\_\_\_ Fax \_\_\_\_\_

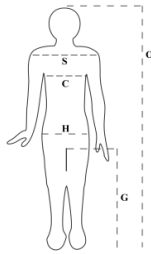

O (Overall Height) \_\_\_\_\_  
 C (Chest Width) \_\_\_\_\_  
 S (Shoulder Width) \_\_\_\_\_  
 H (Hip Width) \_\_\_\_\_  
 G (Groin to Floor) \_\_\_\_\_

Features included in standard price







- Size 1, 2, 3, and 4
- Frame color: 1 = yellow, 2 = red, 3 = blue, 4 = gray
- Base with 4" locking casters
- Height and angle adjustable two-piece footrest
- Tilt from vertical to past horizontal
- Contoured top pad

	Description	Size	Part No.	Price
	Caribou base with parted foot plates	size 1	860101-FP	2,730 <input type="checkbox"/>
	Caribou base with parted foot plates	size 2	860102-FP	2,830 <input type="checkbox"/>
	Caribou base with parted foot plates	size 3	860103-FP	3,135 <input type="checkbox"/>
	Caribou base with parted foot plates	size 4	860104-FP	3,645 <input type="checkbox"/>
	Caribou base with power actuator	size 1	860101-ELFP	4,260 <input type="checkbox"/>
	Caribou base with power actuator	size 2	860102-ELFP	4,360 <input type="checkbox"/>
	Caribou base with power actuator	size 3	860103-ELFP	4,665 <input type="checkbox"/>
	Caribou base with power actuator	size 4	860104-ELFP	5,280 <input type="checkbox"/>
	Top pad, w 1:6", w 2:7", H: 8"	size 1	861101-1	N/C <input type="checkbox"/>
	Top pad, w 1: 7½", w 2: 9", H: 9¾"	size 2	861101-2	N/C <input type="checkbox"/>
	Top pad, w 1: 8½", w 2: 10½", H: 12½"	size 3	861101-3	N/C <input type="checkbox"/>
	Top pad, w 1: 9¾", w 2: 12¼", H: 15¾"	size 4	861101-4	N/C <input type="checkbox"/>
<b>Important: Please select a top pad for the Caribou base</b>				
	Head pad - 7½" height, 6" width	for sizes 1+2	861116-1	505 <input type="checkbox"/>
	Head pad - 9½" height, 8" width	for sizes 3+4	861116-2	505 <input type="checkbox"/>

Description	Size	Part No.	Price
-------------	------	----------	-------

Other Head supports - See Headrest price list for measurements

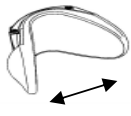
The headrest pads require the Turtle Bar System below!

<b>HCPCS - E0955</b>			
<b>Headrest Style</b>			
	Head support no. 1	6171550	205 <input type="checkbox"/>
	Head support no. 2	6172550	205 <input type="checkbox"/>
	Head support no. 3	6173550	205 <input type="checkbox"/>
	Head support no. 4	6174550	205 <input type="checkbox"/>
	Without cover	0	NC <input type="checkbox"/>
	Blue Comfort	15	65 <input type="checkbox"/>
	Black Decutex	83	65 <input type="checkbox"/>
	Anatomic head support, Small (Black Decutex Cover)	5099001	255 <input type="checkbox"/>
	Anatomic head support, Medium (Black Decutex Cover)	5099002	255 <input type="checkbox"/>
	Anatomic head support, Large (Black Decutex Cover)	5099003	255 <input type="checkbox"/>
	Headband System (For Anatomic Head Support only)	99500	230 <input type="checkbox"/>
	Extra headband strap (For Anatomic Head Support only)	99400-5	56 <input type="checkbox"/>
	Adjustable Width Headrest, large laterals, without speakers**	99737XX-85	305 <input type="checkbox"/>
	Speakers for Adjustable Width Headrest, large laterals	X99717XX-85	95 <input type="checkbox"/>
	**Includes black Mesh cover		
	<b>HCPCS - E1028</b>		
	Swing-away Bracket - Height, Depth, Angle & Lateral Adjustable		
	Turtle bar system, long	98619-26	230 <input type="checkbox"/>

	Chest strap length: 16½" - 25"	for sizes 1+2	862101-2	Quantity _____	120 <input type="checkbox"/>
	Chest strap length: 19" - 30½"	for size 3	862101-3	_____	120 <input type="checkbox"/>
	Chest strap length: 15¾" - 38"	for size 4	862101-4	_____	120 <input type="checkbox"/>

Note: A chest strap is not included as standard, two straps recommended

	Cross straps length: 16½" - 19¼"	size 1	862102-1	280 <input type="checkbox"/>
	Cross straps length: 17" - 21¾"	size 2	862102-2	280 <input type="checkbox"/>
	Cross straps length: 21" - 27½"	size 3	862102-3	295 <input type="checkbox"/>
	Cross straps length: 24¾" - 33¾"	size 4	862102-4	295 <input type="checkbox"/>

	Extra cushion, W: 9¾" H: 3¼"	size 1	861106-1	Quantity _____	230 <input type="checkbox"/>
	Extra cushion, W: 12" H: 4"	size 2	861106-2	_____	230 <input type="checkbox"/>
	Extra cushion, W: 13¾" H: 4"	size 3	861106-3	_____	250 <input type="checkbox"/>
	Extra cushion, W: 15¾" H: 4"	size 4	861106-4	_____	250 <input type="checkbox"/>

	Side supports, set, size 1	all sizes	861102-1	Quantity _____	285 <input type="checkbox"/>
	Side supports, set, size 2	all sizes	861102-2	_____	285 <input type="checkbox"/>
	Side supports, set, size 3	all sizes	861102-3	_____	285 <input type="checkbox"/>









Width between laterals on torso pad (min-max)

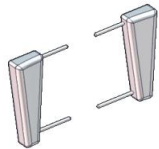
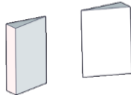



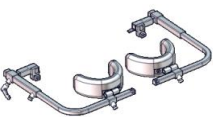
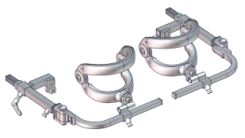

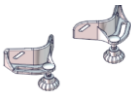
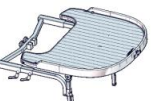
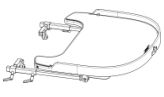



Size 1 - 4" to 9"

Size 2 - 6½" to 14"

Size 3 - 12" to 18"

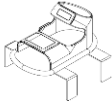
	Lateral support strap length, 10" - 12½"	size 1	862103-1	51 <input type="checkbox"/>
	Lateral support strap length, 12" - 16"	size 2	862103-2	51 <input type="checkbox"/>
	Lateral support strap length, 13½" - 19¾"	size 3	862103-3	51 <input type="checkbox"/>

	Description	Size	Part No.	Price
	Shoulder support, set, w: 3" h: 7½" d: 2"	for size 1	861126-1	255 <input type="checkbox"/>
	Shoulder support, set, w: 3¼" h: 9½" d: 2"	for size 2	861126-2	255 <input type="checkbox"/>
	Shoulder support, set, w: 4" h: 12¼" d: 2"	for size 3	861126-3	255 <input type="checkbox"/>
	Shoulder support, set, w: 4¼" h: 15½" d: 2"	for size 4	861126-4	255 <input type="checkbox"/>
	Wedges for side slots	size 1	861107-1	16 <input type="checkbox"/>
	Wedges for side slots	size 2	861107-2	16 <input type="checkbox"/>
	Wedges for side slots	size 3	861107-3	16 <input type="checkbox"/>
	Back support, small, height adjustable	for size 1	861115-2	295 <input type="checkbox"/>
	Back support, large, height adjustable	for sizes 2+3+4	861115-3	295 <input type="checkbox"/>
	Pommel, w: 2", w: 2¾, h: 6", d: 6¾"	for all sizes	861103-1	135 <input type="checkbox"/>
	Pommel, w: 2", w: 2¾, h: 6", d: 3½"	for all sizes	861103-2	135 <input type="checkbox"/>
	Pommel strap, length: 10" - 12"	for all sizes	862104-1	145 <input type="checkbox"/>
	Pommel strap, length: 10½" - 18½"	for all sizes	862104-2	145 <input type="checkbox"/>
	Knee support, fixed, size 1	for sizes 1+2	861144-2	385 <input type="checkbox"/>
	Knee support, swing away, size 1	for sizes 1+2	861154-2	665 <input type="checkbox"/>
	Knee support, fixed, size 2	for sizes 3+4	861144-3	385 <input type="checkbox"/>
	Knee support, swing away, size 2	for sizes 3+4	861154-3	665 <input type="checkbox"/>
	Knee support, hinged, fixed, size 1	for sizes 1+2	861144-20	535 <input type="checkbox"/>
	Knee support, hinged, swing away, size 1	for sizes 1+2	861154-20	815 <input type="checkbox"/>
	Knee support, hinged, fixed, size 2	for sizes 3+4	861144-30	535 <input type="checkbox"/>
	Knee support, hinged, swing away, size 2	for sizes 3+4	861154-30	815 <input type="checkbox"/>
	Formed foot plates, set, 8½"L, 3"W at heel, 4"W at toe		86147	165 <input type="checkbox"/>
	Formed foot plates, set, 9½"L, 3½"W at heel, 4½"W at toe		86148	165 <input type="checkbox"/>
	Foot straps with plastic locks	all sizes	36-8596	36 <input type="checkbox"/>
	Foot straps with Velcro	all sizes	36-8502	36 <input type="checkbox"/>
	Heel support for parted foot support, set	for size 1+2	861251	56 <input type="checkbox"/>
	Heel support for parted foot support, set	for size 3+4	861252	56 <input type="checkbox"/>
	Tray, plastic, with bowl and cover	size 1+2	862130-2	560 <input type="checkbox"/>
	Tray, plastic, with bowl and cover	size 3+4	862130-3	560 <input type="checkbox"/>
	<i>Low mount tray recommended for size 1 and 2 Caribou</i>			
	Tray, plastic, with bowl and cover, low mount	size 1	862131-1	560 <input type="checkbox"/>
	Tray, plastic, with bowl and cover, low mount	sizes 2+3	862131-2	560 <input type="checkbox"/>
	Kit for low mount of trays (862130-2+862130-3)	for sizes 1-3	862131-KIT	205 <input type="checkbox"/>
	<i>For supine use only</i>			
	Arm rests for plastic tray	all sizes	861131	160 <input type="checkbox"/>
	Toybar for plastic tray	all sizes	861135	240 <input type="checkbox"/>
	Grip handle for plastic tray	all sizes	8910750	405 <input type="checkbox"/>
	Push handle	all sizes	861108-U	140 <input type="checkbox"/>

vests and belts™	Description	HPCPS	Size	Part No.	Price
	Fix locks - <i>required for use of vests</i>		one size	862109-35	42 <input type="checkbox"/>
	The vests are available in net or black - xx = 40: net or 60: black				
	Cross vest	K0108	size 0	89625-0xx	190 <input type="checkbox"/>
	Cross vest	K0108	size 1	89625-1xx	190 <input type="checkbox"/>
	Cross vest	K0108	size 2	89625-2xx	190 <input type="checkbox"/>
	Cross vest	K0108	size 3	89625-3xx	190 <input type="checkbox"/>
	Cross vest	K0108	size 4	89625-4xx	190 <input type="checkbox"/>
	Vest	K0108	size 0	89111-0xx	200 <input type="checkbox"/>
	Vest	K0108	size ¾	89111-075xx	200 <input type="checkbox"/>
	Vest	K0108	size 1	89111-1xx	200 <input type="checkbox"/>
	Vest	K0108	size 2	89111-2xx	200 <input type="checkbox"/>
	Vest	K0108	size 3	89111-3xx	200 <input type="checkbox"/>
	Vest	K0108	size 4	89111-4xx	200 <input type="checkbox"/>
	Neoprene Vest	K0108	size 1	89113-1	200 <input type="checkbox"/>
	Neoprene Vest	K0108	size 2	89113-2	200 <input type="checkbox"/>
	Neoprene Vest	K0108	size 3	89113-3	200 <input type="checkbox"/>
	Sternum Belt	K0108	size 0	SG85430-0	120 <input type="checkbox"/>
	Sternum Belt	K0108	size 1	SG85430-1	120 <input type="checkbox"/>
	Sternum Belt	K0108	size 2	SG85430-2	120 <input type="checkbox"/>
	Chest Belt, Upholstered	K0108	size 1	85428-1	270 <input type="checkbox"/>
	Chest Belt, Upholstered	K0108	size 2	85428-2	270 <input type="checkbox"/>
	Chest Belt, Upholstered	K0108	size 3	85428-3	270 <input type="checkbox"/>
	Chest Belt, Upholstered	K0108	size 4	85428-4	270 <input type="checkbox"/>
	Upholstered ankle strap	K0108	size 1	85426-1	185 <input type="checkbox"/>
	Upholstered ankle strap	K0108	size 2	85426-2	185 <input type="checkbox"/>
	Upholstered ankle strap	K0108	size 3	85426-3	185 <input type="checkbox"/>
	Upholstered ankle strap	K0108	size 4	85426-4	185 <input type="checkbox"/>
	Neoprene sandals, set		one size	85696-1	130 <input type="checkbox"/>
	Footstraps with plastic lock	E0951	one size	36-8596	36 <input type="checkbox"/>
	Footstraps with velcro	E0951	one size	36-8502	36 <input type="checkbox"/>
	Wrist cuffs		size 1	85425-1	82 <input type="checkbox"/>
	Wrist cuffs		size 2	85425-2	82 <input type="checkbox"/>
	Wrist cuffs		size 3	85425-3	82 <input type="checkbox"/>
	Wrist cuffs		size 4	85425-4	82 <input type="checkbox"/>
	Formed foot plates, set, 8.5" long			86147	165 <input type="checkbox"/>
	Formed foot plates, set, 9.5" long			86148	165 <input type="checkbox"/>



Power Kit, complete  
Power Kit, complete  
Power Kit, complete

sizes 1 & 2	861140	2,320	<input type="checkbox"/>
size 3	861150	2,320	<input type="checkbox"/>
size 4	861160	2,320	<input type="checkbox"/>

**Measurements**

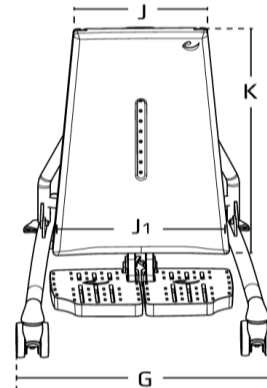
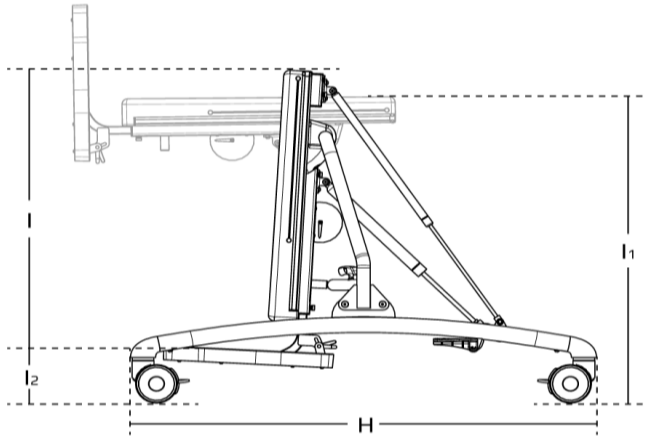

	inch	inch	inch	inch
Frame width (G)	20	22½	25½	29¼
Frame length (H)	29¼	36	43¼	43¼
Height, vertical (I)	18-22½	20¾-25¼	26¾-31	34¾-39
Height, horizontal (I1)	27½	27½	31½	31½
Height from floor to frame (I2)	5	5	5	5
Base pad width, top-bottom (J-J1)	9¾-12½	11¾-15	13¾-18	15¾-21¾
Base pad height (K)	17	19¾	25½	33½
Angling	3° to 90°	3° to 90°	3° to 90°	3° to 90°
Foot plate angling	-10° to 10°	-10° to 10°	-10° to 10°	-10° to 10°
Weight, wo/power	45.2 lb	53 lb	67.2 lb	77.2 lb
Weight, w/power	49.6 lb	56.2 lb	71.7 lb	81.6 lb
Max load	88.2 lb	132.3 lb	176.4 lb	220.5 lb
Supine - User Shoulder Height*	26"-36¾"	30¾"-43"	39½"-51½"	50½"-62½"
Prone - User Armpit Height	18"-36½"	21"-43"	27"-51½"	34½"-62½"

\*Headrest can be added for additional height

**NOTES**